

TDS  
Technical Data Sheet

Release Date  
10 2023



Designed to manage facing linear configurations with ease and functionality, the MDL Light system of task workstations maintains the aesthetics and high performance of MDL System, moving towards greater simplified assembly methods.

## **MDL LIGHT**

**MICHELE DE LUCCHI  
ANGELO MICELI  
GIOVANNI B. MERCURIO**

MDL Light is composed of individual and multiple workstations with fixed or manually adjustable heights and simple desktops with flat edge treatments. Central legs can be added as needed, as well as under-desk cable management trays.

The contoured legs, in extruded aluminium, are fixed directly beneath the desktop, and feature an epoxy powder, anodized aluminium, or polished aluminium finish.

The workstations can be arranged in linear configurations in groups of two, four, six, or eight, separable by divider panels. Shelves, containers, trays, and other accessories, such as monitor arms, binders and stationery trays, can be hung from the panels.

The series is completed by meeting tables of different shapes and sizes, with laminate, melamine, or wood finishes.

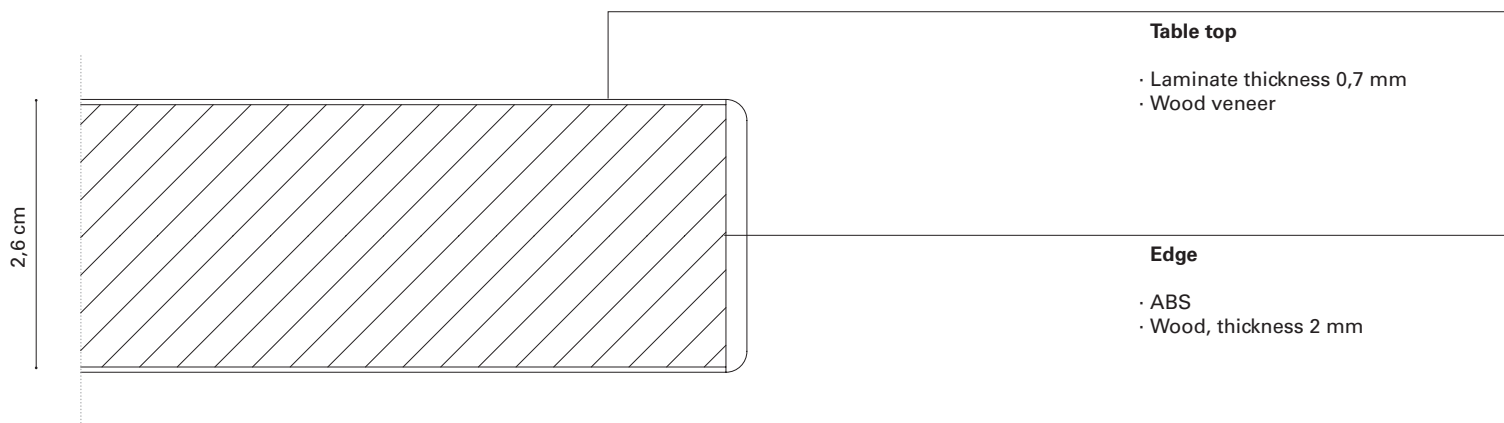
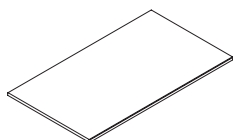

**Table top**

- Laminate thickness 0,7 mm
- Wood veneer

**Edge**

- ABS
- Wood, thickness 2 mm



**TABLETOPS**

**Table tops**

140×80×H2,6 cm  
G DB PI 140 80 ..

160×80×H2,6 cm  
G DB PI 160 80 ..

180×80×H2,6 cm  
G DB PI 180 80 ..

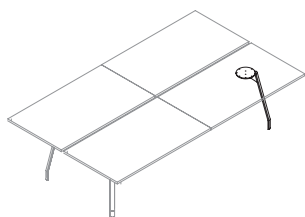

**Height-fixed leg**

5×36×H71 cm  
G DB GA S F ..

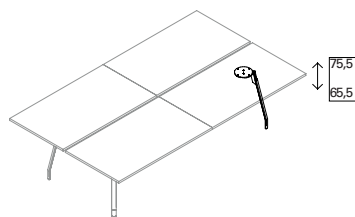

**Height-adjustable leg**

5×36×H65,5/75,5 cm  
G DB GA S R ..

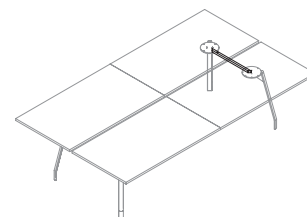

**Support crossbar for double tops**  
Only Platinum Grey

50×2×H2 cm  
G DL PR 50 ..

**LEGS**

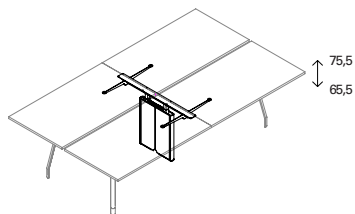
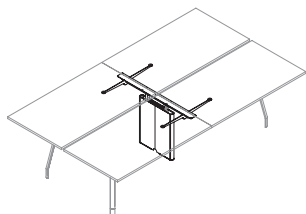

LEGS

**Height-fixed center leg/cable riser for double workstations**

110x74xH71 cm  
G DB GD F ..

**Height-adjustable center leg/cable riser for double workstations**

110x74xH65,5/75,5 cm  
G DB GD R ..

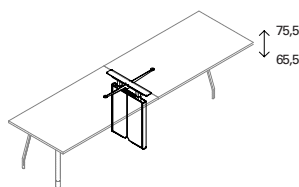
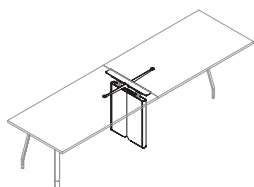

CENTRAL LEGS  
FOR LINEAR WORKSTATIONS

**Height-fixed center leg/cable riser for aligned workstations**

60x74xH71 cm  
G DB GS F ..

**Height-adjustable center leg/cable riser for aligned workstations**

60x74xH65,5/75,5 cm  
G DB GS R ..

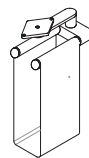
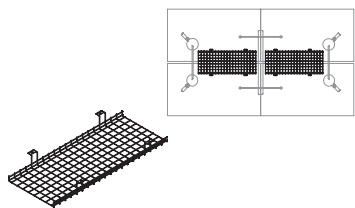
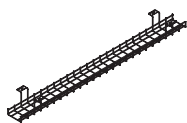

ACCESSORIES

**Cable tray**

100x10xH3,8 cm  
G DB WB 100 ..

125x10xH3,8 cm  
G DB WB 125 ..

150x10xH3,8 cm  
G DB WB 150 ..

**Double cable tray for double workstation**

75x40xH10,2 cm  
G DB WB 75 D ..

100x40xH10,2 cm  
G DB WB 100 D ..

125x40xH10,2 cm  
G DB WB 125 D ..

**CPU holder**

30x14/17xH36/56 cm  
I A UNI Z23 ..

Only for table tops without flip access door  
or with flip access door (I SP 030 10 Z02)  
o (I SP 030 10 Z08)

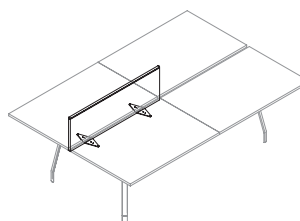
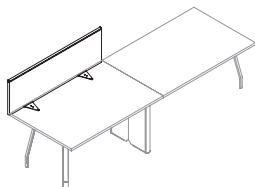

ACCESSORIES

Hanging screens for single table tops

Hanging screens for double table tops

120x2,4xH39 cm  
G DB SC 120 S ..

120x2,4xH39 cm  
G DB SC 120 D ..

140x2,4xH39 cm  
G DB SC 140 S ..

140x2,4xH39 cm  
G DB SC 140 D ..

160x2,4xH39 cm  
G DB SC 160 S ..

160x2,4xH39 cm  
G DB SC 160 D ..

180x2,4xH39 cm  
G DB SC 180 S ..

180x2,4xH39 cm  
G DB SC 180 D ..

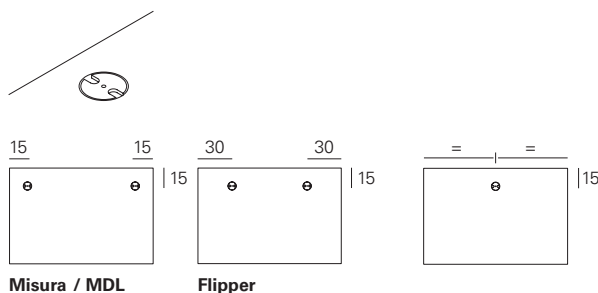
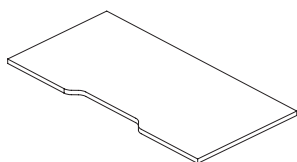

Cable entry slots  
For all table tops

Top access  
Only chromed.  
Specify the position

53,5x6,5xH3 cm  
TS2 SP 53 6A ..

7x7xH3 cm  
D DS 271 9 ..

Z02

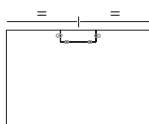
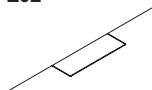

Z08

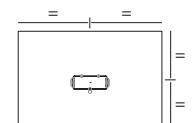
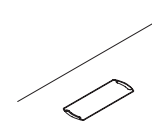
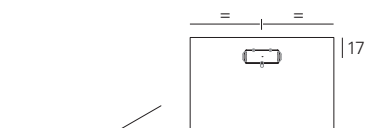
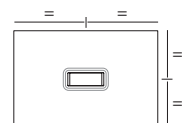
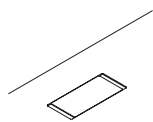
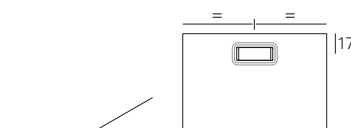
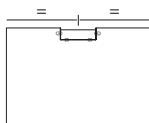
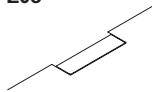

Flip access door  
Same top finish.  
Specify the position

Rectangular flip access door  
Same top finish,  
only for laminate tops.  
Specify the position

Rectangular flip access door  
Same top finish,  
for laminate and veneer tops.  
Specify the position

30x12xH3 cm  
I SP 030 10 Z02 ..

30x11xH3 cm  
P D P CAB Z24 ..

30x11xH3 cm  
P D P CAB Z11 ..

30x8xH3 cm  
I SP 030 10 Z08 ..

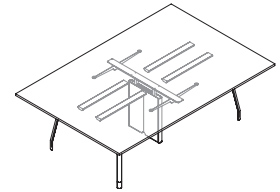
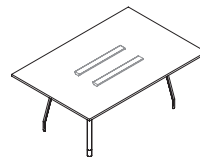
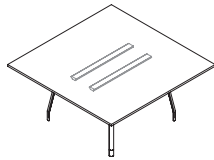

## Q MEETING TABLES

**Square tables  
composed of n.1 table top,  
n.4 legs in BA o NA (G DB GA S F)**

Table top code (G DL PB 120 Q)  
120×120×H73,4 cm  
G L M 120 Q ..

Table top code (G DL PB 140 Q)  
140×140×H73,4 cm  
G L M 120 Q ..

Table top code (G DL PB 160 Q)  
160×160×H73,4 cm  
G L M 160 Q ..

**Rectangular table  
composed of n.1 table top,  
n.4 legs in BA o NA (G DB GA S F)**

Table top code (G DL PB 180 12 Q)  
180×120×H73,4 cm  
G L M 180 120 Q ..

**Rectangular tables  
composed of n.1 table top, n.4 legs  
in BA o NA (G DB GA S F), n.1 central  
leg/cables riser (G DB GD F)**

Table top code (G DL PB 240 12 Q)  
240×120×H73,4 cm  
G L M 240 120 Q ..

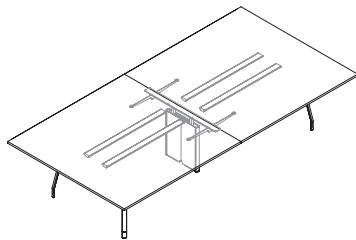

**Rectangular tables  
composed of n.2 table tops,  
n.4 legs in BA o NA (G DB GA S F),  
n.1 central leg/cables riser (G DB  
GD F)**

Table top code (G DL PB 280 14 Q)  
280×140×H73,4 cm  
G L M 280 140 Q ..

Table top code (G DL PI 320 16 Q)  
320×160×H73,4 cm  
G L M 320 160 Q ..

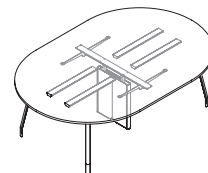

## R-S MEETING TABLES

**Round tables  
composed of n.1 table top,  
n.4 legs in BA o NA (G DB GA S F)**

Table tops codes (G DL PB 090 R)  
90×90×H73,4 cm  
G L M 090 R ..

Table tops codes (G DL PB 120 R)  
120×120×H73,4 cm  
G L M 120 R ..

Table tops codes (G DL PB 140 R)  
140×140×H73,4 cm  
G L M 120 R ..

Table tops codes (G DL PB 160 R)  
160×160×H73,4 cm  
G L M 160 R ..

**Round tables  
composed of n.1 table top,  
n.4 legs in BA o NA (G DB GA S F)**

Table tops codes (G DL PB 180 12 Q)  
180×120×H73,4 cm  
G L M 180 120 S ..

**Tavoli ovali composed of n.1 table  
top, n.4 legs in BA o NA  
(G DB GA S F), n.1 central leg/cables  
riser (G DB GD F)**

Table tops codes (G DL PB 240 12 S)  
240×120×H73,4 cm  
G L M 240 120 S ..

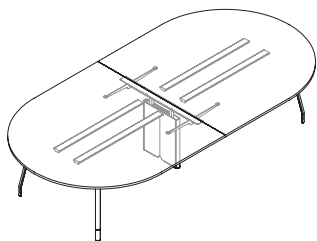

**Tavoli ovali composed of n.2 table tops,  
n.4 legs in BA o NA (G DB GA S F),  
n.1 central leg/cables riser (G DB GD F)**

Table tops codes (G DL PB 280 14 S)  
280×140×H73,4 cm  
G L M 280 140 S ..

Table tops codes (G DL PI 320 16 Q)  
320×160×H73,4 cm  
G L M 320 160 Q ..



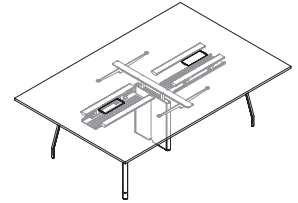
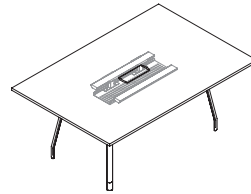
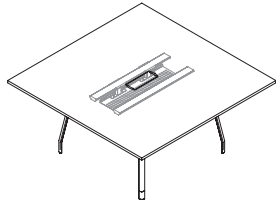

**Q MEETING TABLES, PRE-ARRANGED  
FOR ELECTRIFICATION**

**Square tables  
composed of n.1 table top,  
n.4 legs in BA o NA (G DB GA S F),  
n.1 flip access door (P D P CAB Z11),  
n.1 cable tray (G DB WB 75)**

Table tops codes (G DL PB 140 Q W)  
140x140xH73,4 cm  
G L M 140 Q W ..

Table tops codes (G DL PB 160 Q W)  
160x160xH73,4 cm  
G L M 160 Q W ..

**Rectangular table  
composed of n.1 table top,  
n.4 legs in BA o NA (G DB GA S F),  
n.1 flip access door (P D P CAB Z11),  
n.1 cable tray (G DB WB 75)**

Table tops codes (G DL PB 180 12 Q W)  
180x120xH73,4 cm  
G L M 180 120 Q W ..

**Rectangular tables  
composed of n.1 table top,  
n.4 legs in BA o NA (G DB GA S F),  
n.1 central leg/cables riser  
(G DB GD F),  
n.2 flip access doors (P D P CAB Z11),  
n.2 cable trays (G DB WB 75)**

Table tops codes (G DL PB 240 12 Q W)  
240x120xH73,4 cm  
G L M 240 120 Q W ..

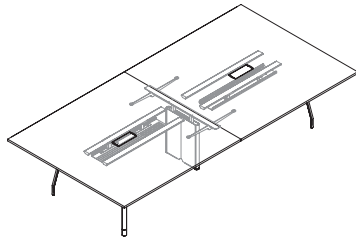

**Rectangular tables  
composed of n.1 table top,  
n.4 legs in BA o NA (G DB GA S F),  
n.1 central leg/cables riser  
(G DB GD F),  
n.2 flip access doors (P D P CAB Z11),  
n.2 cable trays (G DB WB 100)**

Table tops codes (G DL PB 280 14 Q W)  
280x140xH73,4 cm  
G L M 280 140 Q W ..

Table tops codes (G DL PB 320 16 Q  
W)  
320x160xH73,4 cm  
G L M 320 160 Q W ..

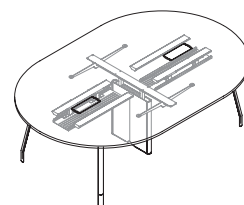
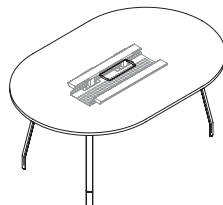
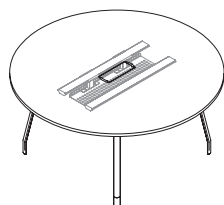
**R-S MEETING TABLES,  
PRE-ARRANGED FOR  
ELECTRIFICATION**

**Round tables composed of n.1 table top, n.4 legs in BA o NA (G DB GA S F), n.1 flip access door (P D P CAB Z11), n.1 cable tray (G DB WB 75)**

Codice piano (G DL PB 140 RW)  
140x140xH73,4 cm  
G L M 140 R W ..

Codice piano (G DL PB 160 RW)  
160x160xH73,4 cm  
G L M 160 R W ..

**Oval tables composed of n.1 table top, n.4 legs in BA o NA (G DB GA S F), n.1 flip access door (P D P CAB Z11), n.1 cable tray (G DB WB 75)**

Codice piano (G DL PB 180 12 SW)  
180x120xH73,4 cm  
G L M 180 120 S W ..

**Oval tables composed of n.1 table top, n.4 legs in BA o NA (G DB GA S F), n.1 central leg/cables riser (G DB GD F), n.2 flip access doors (P D P CAB Z11), n.2 cable trays (G DB WB 75)**

Codice piano (G DL PB 240 12 SW)  
240x120xH73,4 cm  
G L M 240 120 S W ..

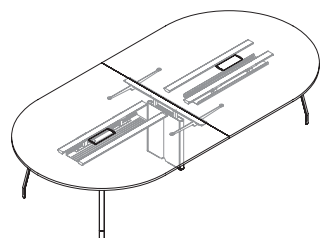

**Oval tables composed of n.1 table top, n.4 legs in BA o NA (G DB GA S F), n.1 central leg/cables riser (G DB GD F), n.2 flip access doors (P D P CAB Z11), n.2 cable trays (G DB WB 100)**

Codice piano (G DL PB 280 14 SW)  
280x140xH73,4 cm  
G L M 280 140 S W ..

Codice piano (G DL PB 320 16 S W)  
320x160xH73,4 cm  
G L M 320 160 S W .



**Flexible cable riser with side zipper**  
Only black

7x1xH67 cm  
I A SCF ET ..



**Flexible cable riser**  
Only trasparente

13x13xH60 cm  
I A SCF B ..

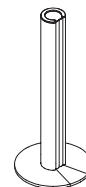

**Round cables riser**

25x25xH43,5 cm  
I A SC Z02 ..

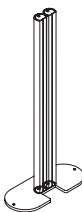

**Cables riser**

27,8x12xH53,5 cm  
I A SC Z17 ..

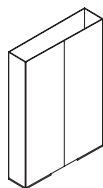

**Cables riser cover**  
Only Chrome painted (3C)

34,8x8xH55,4 cm  
Y NO A SC Z01 ..

**TABLE TOPS AND COMBINATIONS**  
**TABLE TOPS/STRUCTURES FINISHES**  
(Structure in: BA- NA)

Melamine



**4S**  
White melamine



**PN**  
Platinum Grey melamine



**NY**  
Oak melamine

Laminate

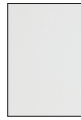

**S4**  
White laminate

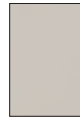

**GP**  
Platinum Grey laminate

Photolaminate



**LS**  
Sycamore laminate



**NY**  
Natural Oak laminate

Standard natural veneer  
(certified genuine wood  
from Europe - Canada - USA)



**AS**  
Sycamore



**RV**  
Natural Oak

For combinations of table tops/structure,  
it is necessary to specify when ordering  
the finish of the structure

**LEGS AND STRUCTURES FINISHES**

Epoxy powder coating



**D7**  
Charcoal painting



**T0**  
Ash painting



**VP**  
Platinum Grey painting



**C7**  
Calce White painting



**KS**  
Soft black painting

Galvanic treatment



**BA**  
Polished aluminum



**NA**  
Natural aluminum

For other finishes,  
please contact our Sales Department

**ELECTRIFICATION, ACCESSORIES,  
CABLES RISERS**

Epoxy powder coating



**D7**  
Charcoal painting



**T0**  
Ash painting



**VP**  
Platinum Grey painting



**C7**  
Calce White painting



**KS**  
Soft black painting

**HANGING SCREENS FINISHES**

Profiles in: D7-T0-VP- C7- KS

Laminato

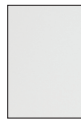

**S4**  
White laminate



**GP**  
Platinum Grey laminate



**LS**  
Sycamore laminate



**RY**  
Natural Oak laminate

Fabric

Profiles in: D7-T0-VP- C7- KS



**J2**  
COM fabric

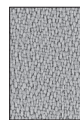

**J3**  
Mirage fabric



**Q0**  
Revive 1 fabric



**Q1**  
Chip fabric



**Q2**  
File fabric



**K3**  
Remix 3 fabric



**K4**  
Sole fabric

Glass

Polycarbonate profiles



**CS**  
Frosted glass

It is necessary to specify when ordering  
the finish of the structure

For other finishes,  
please contact our Sales Department



ISO 9001



ISO 14001

UniFor has management system certified according to UNI EN ISO 9001 and UNI EN ISO 14001. The products are in conformance with the Italian decree law DLGS 81:2008 and with all of the principal regulations applicable to the various types of products.

The products described in this catalog are made with class E1 materials (low formaldehyde content) and are Greenguard® certified.