

TDS  
Technical Data Sheet

Release Date  
2023



Progettato per gestire con facilità e funzionalità le configurazioni contrapposte aggregate in linea, il sistema operativo MDL Light mantiene inalterato l'estetica e le elevate prestazioni tecniche che caratterizzano MDL System, orientandosi ad una maggiore semplificazione costruttiva.

MDL Light è composto da postazioni di lavoro singole e multiple, disponibili con piano ad altezza fissa o regolabile manualmente. Il sistema è caratterizzato da un piano di lavoro semplice, con bordo rettilineo, attrezzabile con gambe centrali e cestelli sotto piano per la raccolta e gestione dei cavi di alimentazione.

Le gambe, sagomate e fissate al piano, sono realizzate in estruso di alluminio verniciato a polveri o in alluminio anodizzato o brillantato.

Le postazioni di lavoro, configurabili in linea a gruppi di due, quattro, sei o otto, possono essere separate da schermi divisorii a cui possono essere agganciati accessori quali mensole, contenitori e complementi in dotazione alla serie quali bracci porta monitor e raccoglitori e vaschette.

La serie si completa di tavoli meeting di diverse forme e dimensioni nelle finiture laminato, melaminico ed essenza.

## DETTAGLIO BORDO PIANO

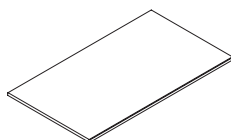
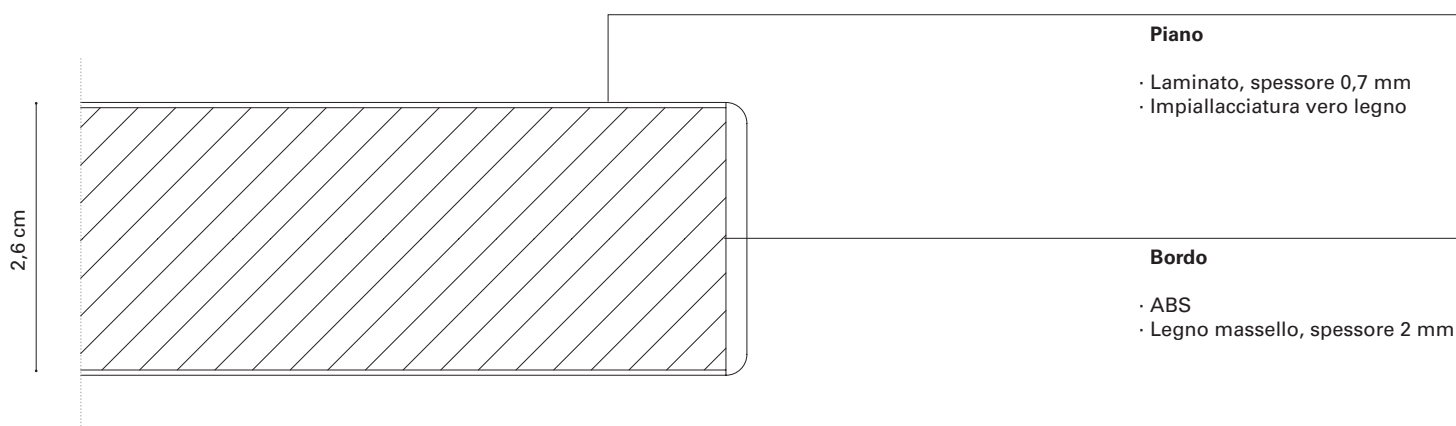

## PIANI

## Piani

140×80×H2,6 cm  
G DB PI 140 80 ..

160×80×H2,6 cm  
G DB PI 160 80 ..

180×80×H2,6 cm  
G DB PI 180 80 ..

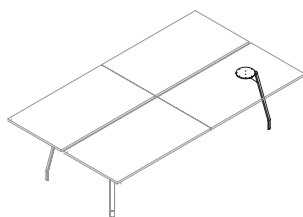

## GAMBE

## Gamba altezza fissa

5×36×H71 cm  
G DB GA S F ..

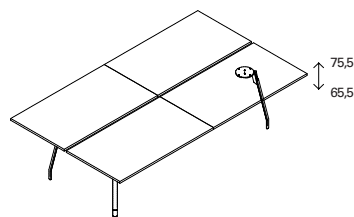

## Gamba regolabile in altezza

5×36×H65,5/75,5 cm  
G DB GA S R ..

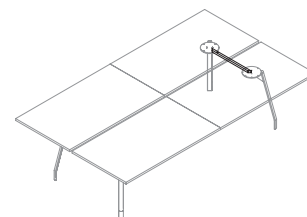
Traversa di sostegno per piani doppi  
Solo Grigio Platino

50×2×H2 cm  
G DL PR 50 ..

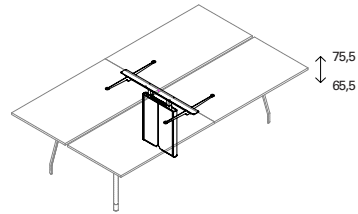
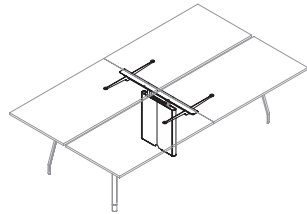
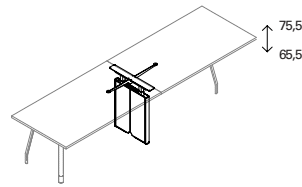
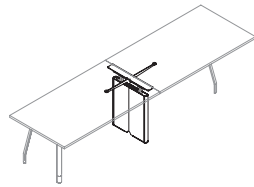
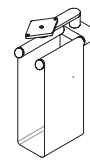
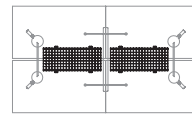
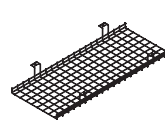
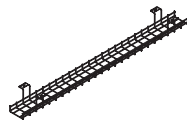
**GAMBE CENTRALI  
PER POSTAZIONI DOPPIE****Gamba centrale/salita cavi fissa**110x74xH71 cm  
G DB GD F ..**Gamba centrale/salita cavi,  
regolabile in altezza**110x74xH65,5/75,5 cm  
G DB GD R ..**GAMBE CENTRALI  
PER POSTAZIONI IN LINEA****Gamba centrale/salita cavi fissa  
per postazioni in linea**60x74xH71 cm  
G DB GS F ..**Gamba centrale/salita cavi  
regolabile in altezza  
per postazioni in linea**60x74xH65,5/75,5 cm  
G DB GS R ..**ACCESSORI****Cestello per raccolta cavi**100x10xH3,8 cm  
G DB WB 100 ..125x10xH3,8 cm  
G DB WB 125 ..150x10xH3,8 cm  
G DB WB 150 ..**Cestello doppio per raccolta cavi  
per postazione doppia**75x40xH10,2 cm  
G DB WB 75 D ..100x40xH10,2 cm  
G DB WB 100 D ..125x40xH10,2 cm  
G DB WB 125 D ..Solo per piani senza sportello  
o con sportello (I SP 030 10 Z02)  
o (I SP 030 10 Z08)**Porta unità centrale**30x14/17xH36/56 cm  
I A UNI Z23 ..

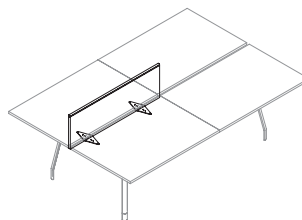
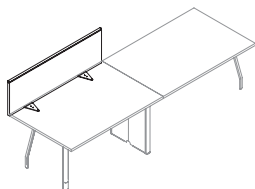

ACCESSORI

Schermi pensili per piani singoli

120x2,4xH39 cm  
G DB SC 120 S ..

140x2,4xH39 cm  
G DB SC 140 S ..

160x2,4xH39 cm  
G DB SC 160 S ..

180x2,4xH39 cm  
G DB SC 180 S ..

Schermi pensili per piani doppi

120x2,4xH39 cm  
G DB SC 120 D ..

140x2,4xH39 cm  
G DB SC 140 D ..

160x2,4xH39 cm  
G DB SC 160 D ..

180x2,4xH39 cm  
G DB SC 180 D ..

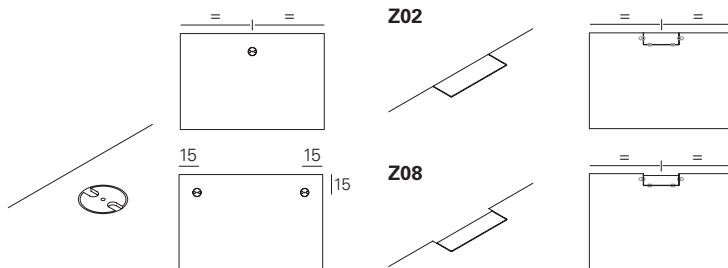
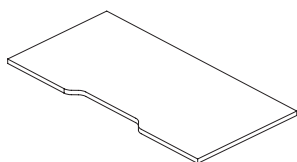

SPORTELLI  
PASSACAVI

Asolatura passacavi  
Per tutti i piani

53,5x6,5xH3 cm  
TS2 SP 53 6A ..

Passacavi  
Solo cromato  
Specificare la posizione

7x7xH3 cm  
D DS 271 9 ..

Sportello passacavi  
Stessa finitura del piano  
Specificare la posizione

30x12xH3 cm  
I SP 030 10 Z02 ..

30x8xH3 cm  
I SP 030 10 Z08 ..

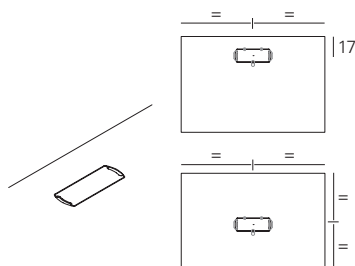
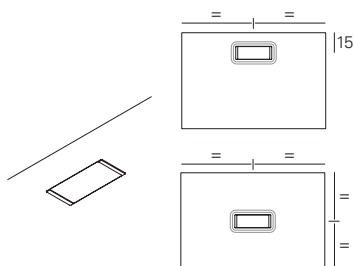

Sportello passacavi rettangolare  
Stessa finitura del piano,  
solo per piani in laminato  
Specificare la posizione

30x11xH3 cm  
P D P CAB Z24 ..

Sportello passacavi rettangolare  
Stessa finitura del piano,  
solo per piani in laminato e legno  
Specificare la posizione

30x11xH3 cm  
P D P CAB Z11 ..

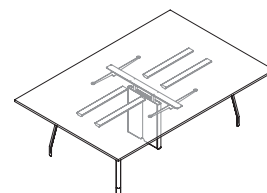
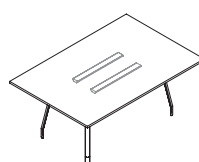
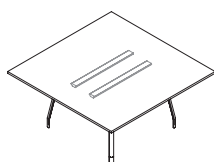

## TAVOLI MEETING Q

**Tavoli quadrati  
composti da n.1 piano,  
n.4 gambe in BA o NA (G DB GA S F)**

Codice piano (G DL PB 120 Q)  
120×120×H73,4 cm  
G L M 120 Q ..

Codice piano (G DL PB 140 Q)  
140×140×H73,4 cm  
G L M 120 Q ..

Codice piano (G DL PB 160 Q)  
160×160×H73,4 cm  
G L M 160 Q ..

**Tavolo rettangolare  
composti da n.1 piano,  
n.4 gambe in BA o NA (G DB GA S F)**

Codice piano (G DL PB 180 12 Q)  
180×120×H73,4 cm  
G L M 180 120 Q ..

**Tavoli rettangolari composti da  
n.1 piano, n.4 gambe in BA o NA  
(G DB GA S F), n.1 gamba  
centrale/salita cavi (G DB GD F)**

Codice piano (G DL PB 240 12 Q)  
240×120×H73,4 cm  
G L M 240 120 Q ..

Codice piano (G DL PB 280 14 Q)  
280×140×H73,4 cm  
G L M 280 140 Q ..

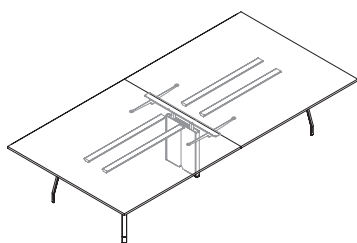

**Tavoli rettangolari  
composti da n.2 piani,  
n.4 gambe in BA o NA (G DB GA S F),  
n.1 gamba centrale/salita cavi (G DB GD F)**

Codice piano (G DL PI 320 16 Q)  
320×160×H73,4 cm  
G L M 320 160 Q ..

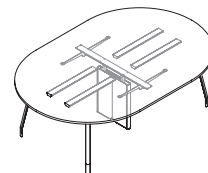

## TAVOLI MEETING R-S

**Tavoli tondi  
composti da n.1 piano,  
n.4 gambe in BA o NA (G DB GA S F)**

Codice piano (G DL PB 090 R)  
90×90×H73,4 cm  
G L M 090 R ..

Codice piano (G DL PB 120 R)  
120×120×H73,4 cm  
G L M 120 R ..

Codice piano (G DL PB 140 R)  
140×140×H73,4 cm  
G L M 120 R ..

Codice piano (G DL PB 160 R)  
160×160×H73,4 cm  
G L M 160 R ..

**Tavolo ovale  
composti da n.1 piano,  
n.4 gambe in BA o NA (G DB GA S F)**

Codice piano (G DL PB 180 12 Q)  
180×120×H73,4 cm  
G L M 180 120 S ..

**Tavoli ovali composti da  
n.1 piano, n.4 gambe in BA o NA  
(G DB GA S F), n.1 gamba  
centrale/salita cavi (G DB GD F)**

Codice piano (G DL PB 240 12 S)  
240×120×H73,4 cm  
G L M 240 120 S ..

Codice piano (G DL PB 280 14 S)  
280×140×H73,4 cm  
G L M 280 140 S ..

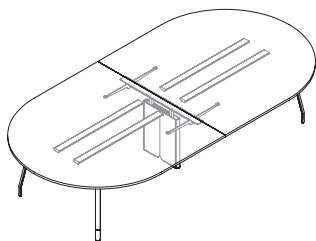

**Tavoli ovali composti da n.2 piani,  
n.4 gambe in BA o NA (G DB GA S F),  
n.1 gamba centrale/salita cavi (G DB GD F)**

Codice piano (G DL PI 320 16 Q)  
320×160×H73,4 cm  
G L M 320 160 Q ..

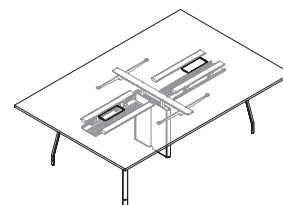
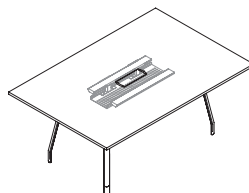
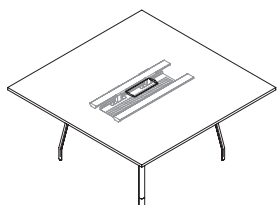

**TAVOLI MEETING Q, PREDISPOSTI  
PER ELETRIFICAZIONE**

**Tavoli quadrati  
composti da n.1 piano,  
n.4 gambe in BA o NA (G DB GA S F),  
n.1 sportello (P D P CAB Z11),  
n.1 cestello (G DB WB 75)**

Codice piano (G DL PB 140 Q W)  
140x140xH73,4 cm  
G L M 140 Q W ..

Codice piano (G DL PB 160 Q W)  
160x160xH73,4 cm  
G L M 160 Q W ..

**Tavolo rettangolare  
composti da n.1 piano,  
n.4 gambe in BA o NA (G DB GA S F),  
n.1 sportello (P D P CAB Z11),  
n.1 cestello (G DB WB 75)**

Codice piano (G DL PB 180 12 Q W)  
180x120xH73,4 cm  
G L M 180 120 Q W ..

**Tavoli rettangolari  
composti da n.1 piano,  
n.4 gambe in BA o NA (G DB GA S F),  
n.1 gamba centrale/salita cavi  
(G DB GD F),  
n.2 sportelli (P D P CAB Z11),  
n.2 cestelli (G DB WB 75)**

Codice piano (G DL PB 240 12 Q W)  
240x120xH73,4 cm  
G L M 240 120 Q W ..

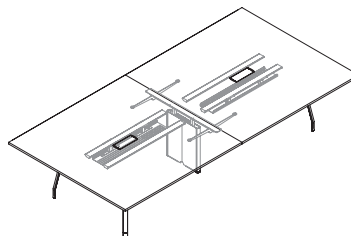
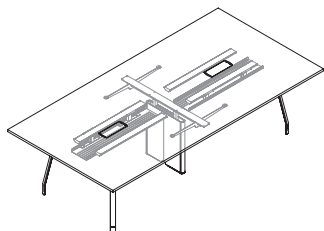

**Tavolo rettangolare  
composti da n.1 piano,  
n.4 gambe in BA o NA (G DB GA S F),  
n.1 gamba centrale/salita cavi  
(G DB GD F),  
n.2 sportelli (P D P CAB Z11),  
n.2 cestelli (G DB WB 100)**

Codice piano (G DL PB 280 14 Q W)  
280x140xH73,4 cm  
G L M 280 140 Q W ..

**Tavoli rettangolari  
composti da n.2 piani,  
n.4 gambe in BA or NA (G DB GA S F),  
n.1 gamba centrale/salita cavi  
(G DB GD F),  
n.2 sportelli (P D P CAB Z11),  
n.2 cestelli (G DB WB 100)**

Codice piano (G DL PB 320 16 Q W)  
320x160xH73,4 cm  
G L M 320 160 Q W ..

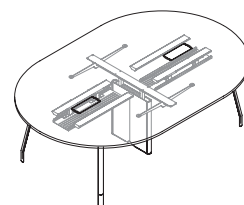
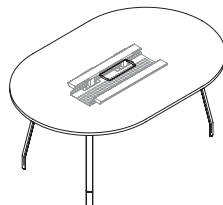
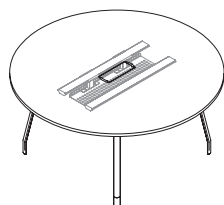

**TAVOLI MEETING R-S, PREDISPOSTI  
 PER ELETRIFICAZIONE**

**Tavoli tondi composti da n.1 piano,  
 n.4 gambe in BA o NA (G DB GA S F),  
 n.1 sportello (P D P CAB Z11),  
 n.1 cestello (G DB WB 75)**

Codice piano (G DL PB 140 RW)  
 140x140xH73,4 cm  
 G L M 140 R W ..

Codice piano (G DL PB 160 RW)  
 160x160xH73,4 cm  
 G L M 160 R W ..

**Tavolo ovale composti da n.1 piano,  
 n.4 gambe in BA o NA (G DB GA S F),  
 n.1 sportello (P D P CAB Z11),  
 n.1 cestello (G DB WB 75)**

Codice piano (G DL PB 180 12 SW)  
 180x120xH73,4 cm  
 G L M 180 120 S W ..

**Tavoli ovali composti da n.1 piano,  
 n.4 gambe in BA o NA (G DB GA S F),  
 n.1 gamba centrale/salita cavi  
 (G DB GD F), n.2 sportelli (P D P CAB  
 Z11), n.2 cestelli (G DB WB 75)**

Codice piano (G DL PB 240 12 SW)  
 240x120xH73,4 cm  
 G L M 240 120 S W ..

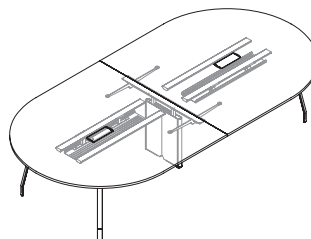
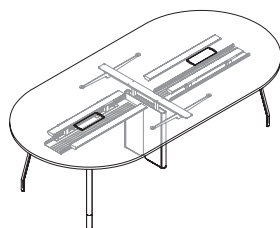

**Tavoli ovali composti da n.1 piano,  
 n.4 gambe in BA o NA (G DB GA S F),  
 n.1 gamba centrale/salita cavi  
 (G DB GD F),  
 n.2 sportelli (P D P CAB Z11),  
 n.2 cestelli (G DB WB 100)**

Codice piano (G DL PB 280 14 SW)  
 280x140xH73,4 cm  
 G L M 280 140 S W ..

**Tavoli ovali composti da n.2 piani,  
 n.4 gambe in BA or NA (G DB GA S F),  
 n.1 gamba centrale/salita cavi  
 (G DB GD F),  
 n.2 sportelli (P D P CAB Z11),  
 n.2 cestelli (G DB WB 100)**

Codice piano (G DL PB 320 16 SW)  
 320x160xH73,4 cm  
 G L M 320 160 S W ..



**Salita cavi flessibile**  
Solo trasparente

13x13xH60 cm  
I A SCF B ..

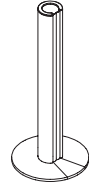

**Salita cavi rotonda**

25x25xH43,5 cm  
I A SC Z02 ..



**Salita cavi**

27,8x12xH53,5 cm  
I A SC Z17 ..

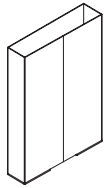

**Carter salita cavi**  
Solo verniciato Cromo (3C)

34,8x8xH55,4 cm  
Y NO A SC Z01 ..

**FINITURE PIANI E  
COMBINAZIONE PIANI/STRUTTURE**  
(Strutture in: BA- NA)

Melaminico

**4S**  
Melaminico Bianco**PN**  
Melaminico Grigio Platino**NY**  
Melaminico Rovere

Laminato





**S4**  
Laminato Bianco**GP**  
Laminato Grigio Platino**LS**  
Laminato Acero Sicomoro**RY**  
Laminato RovereLegno naturale standard  
(certificato vero legno di provenienza  
Europa - Canada - USA)**AS**  
Acero Sicomoro**RV**  
Rovere naturaleNelle combinazioni piano/strutture  
è necessario specificare al momento  
dell'ordine la finitura della struttura**FINITURE GAMBE E STRUTTURE**

Verniciatura con polvere epossidica

**D7**  
Verniciatura Charcoal**T0**  
Verniciatura Ash**VP**  
Verniciatura Grigio platino**C7**  
Verniciatura Bianco Calce**KS**  
Verniciatura Nero Soft

Trattamento galvanico



**BA**  
Alluminio brillantato**NA**  
Alluminio naturalePer altre finiture a richiesta,  
contattare il nostro Ufficio Commerciale

	<b>D7</b> Verniciatura Charcoal		<b>T0</b> Verniciatura Ash		<b>VP</b> Verniciatura Grigio platino
	<b>C7</b> Verniciatura Bianco Calce		<b>KS</b> Verniciatura Nero Soft		





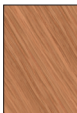

**FINITURE SCHERMI PENSILI**

Profili in: D7-T0-VP- C7- KS

Laminato

	<b>S4</b> Laminato Bianco		<b>GP</b> Laminato Grigio Platino
	<b>LS</b> Laminato Acero Sicomoro		<b>RY</b> Laminato Rovere

Tessuto

	<b>J2</b> Tessuto cliente		<b>J3</b> Tessuto Mirage		
	<b>Q0</b> Tessuto Revive 1		<b>Q1</b> Tessuto Chip		<b>Q2</b> Tessuto File
	<b>K3</b> Tessuto Remix 2		<b>K4</b> Tessuto Sole		

Vetro

	<b>CS</b> Vetro satinato
---	-----------------------------

È necessario specificare al momento dell'ordine la finitura della struttura

Per altre finiture a richiesta,  
contattare il nostro Ufficio Commerciale



UniFor ha ottenuto le certificazioni dei sistemi di gestione UNI EN ISO 9001 e UNI EN ISO 14001. I prodotti sono conformi all'allegato DLGS 81:2008 e rispondenti alle principali norme applicabili ai diversi tipi di prodotti.



I prodotti descritti nel catalogo sono composti da materiali in classe E1 (a basso contenuto di formaldeide) e hanno ottenuto la certificazione Greenguard®.