

TDS
Technical Data Sheet

Release Date
2023



First created expressly for the Cartier Foundation in Paris, the Less series of furnishings is characterised by compositional rigor and elegant forms reduced to their essence.

A modular system, Less was conceived to inhabit the contemporary workplace but not only. Less tables, containers, and bookcases are solid metal structures defined by clean lines, smooth surfaces and compact silhouettes.

Tables

The Less table is configured as a monolithic structure made entirely of metal; the legs consist of steel bars in L-shaped profiles, 8 mm thick, while the top is made entirely of folded sheet iron.

Available in both rectangular and square forms, in various sizes and two different heights, the table can be used as a meeting table or as an operative desk, the latter in both executive and workstation versions, also in L-configurations, with additional worktop.

Drawer pedestals

The drawer pedestal is equipped with skid feet, or wheels upon request, and has three drawers, one of which for hanging folders. A fall-front door at the rear provides access to a space for cable management.

Totem

Totem is a tall swivel cabinet on a fixed base with two compartments created by a vertical internal partition, accessible by means of doors on opposite sides. The doors feature a special opening mechanism with combined rotation and lateral movement. Each cabinet has eight metal shelves.

Bookcases

The Less bookcase consists of folded metal shelves fixed firmly to slender L-shaped metal uprights. Produced in various lengths and heights (with two, three, or four shelves), the bookshelf is available in a completely open version or with fall-front doors which serve, in the open position, as handy surfaces for consulting reading material.

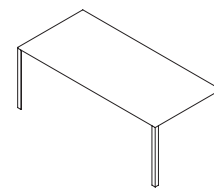
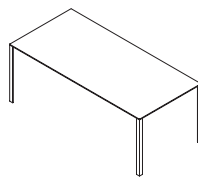
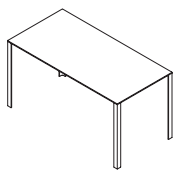

TABLES

Tables with depth 70 cm

110×70×H72 cm
C LS 110 70 ..

140×70×H72 cm
C LS 140 70 ..

210×70×H72 cm
C LS 210 70 ..

Tables with depth 80 cm

160×80×H72 cm
C LS 160 80 ..

Tables with depth 90 cm

Pre-arranged for return connection

190×90×H72 cm
C LS 190 90 ..

240×90×H72 cm
C LS 240 90 ..

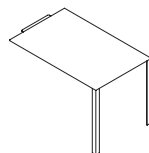
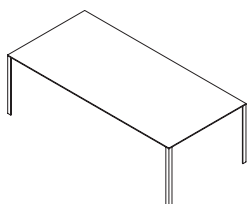
**Tables with depth 110 cm**

Pre-arranged for return connection

230×110×H72 cm
C LS 230 110 ..

Return

110×70×H72 cm
C LS 110 70 L ..

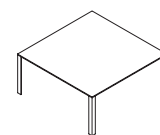
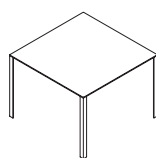
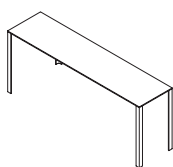
**Tavoli con profondità 45 cm**

180×45×H72 cm
C LS 180 45 ..

Square tables

100×100×H72 cm
C LS 100 100 ..

140×140×H72 cm
C LS 140 140 ..

Low square table

100×100×H45 cm
C LS 100 100 B ..

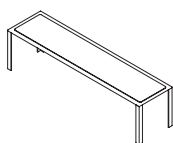

BENCH

Bench with black leather cushion

180×45×H45 cm
C LS 180 45 P ..

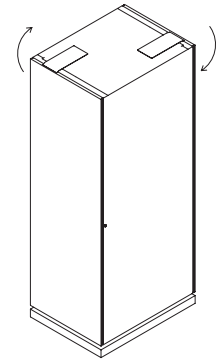
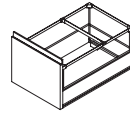
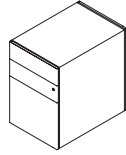

<p>CABINETS</p>	<p>Two drawers and one file drawer pedestal Inspectionable back, not on wheels 41×60×H62 cm C LS 41 60 C3 ..</p>	<p>Filing frame 29×46×H26 cm D DS 522 41 ..</p>	<p>Rotating tower cabinet, double-sided 60×80×H192 cm C LS 60 190 ..</p>
-----------------	---------------------------------------------------------------------------------------------------------------------------------------------------------------------------------------------	-------------------------------------------------------------------------------------------------------	--------------------------------------------------------------------------------------------------------------------------------

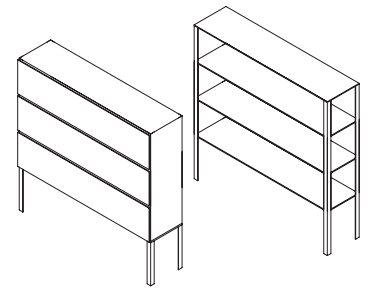
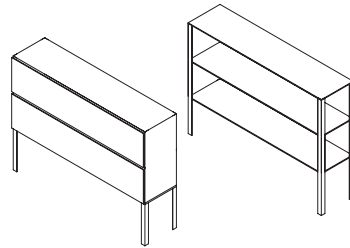
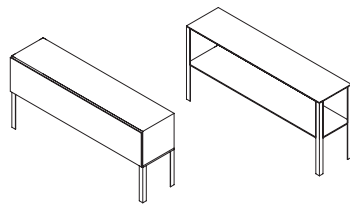

<p>CONTENITORI</p>	<p>Library height 80 cm Closed version with flap door 160×45×H80 cm C LS 160 080 A .. Open version 160×40×H80 cm C LS 160 080 G ..</p>	<p>Library height 120 cm Closed version with flap door 160×45×H120 cm C LS 160 120 A .. Open version 160×40×H120 cm C LS 160 120 G ..</p>	<p>Library height 160 cm Closed version with flap door 160×45×H80 cm C LS 160 160 A .. Open version 160×40×H80 cm C LS 160 160 G ..</p>
--------------------	---------------------------------------------------------------------------------------------------------------------------------------------------------------------------------------------------------------------------------------------------------------------------------------	------------------------------------------------------------------------------------------------------------------------------------------------------------------------------------------------------------------------------------------------------------------------------------------	----------------------------------------------------------------------------------------------------------------------------------------------------------------------------------------------------------------------------------------------------------------------------------------

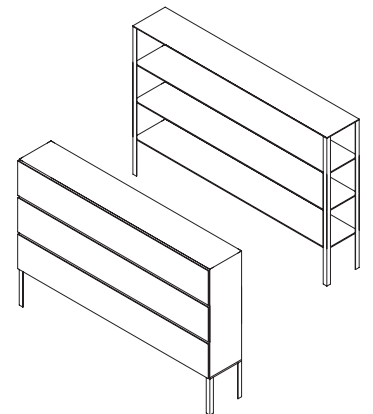
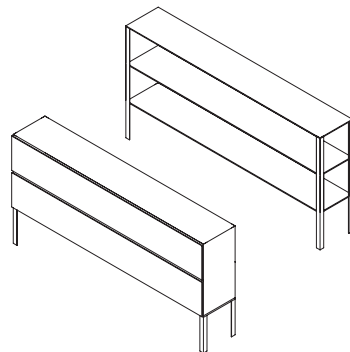
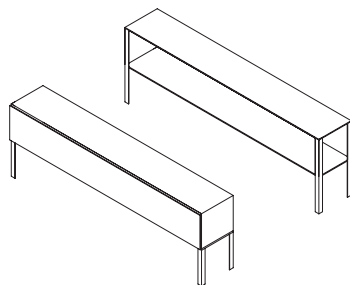

<p>CONTENITORI</p>	<p>Library height 80 cm Closed version with flap door 240×45×H80 cm C LS 240 080 A .. Open version 240×40×H80 cm C LS 240 080 G ..</p>	<p>Library height 120 cm Closed version with flap door 240×45×H120 cm C LS 240 120 A .. Open version 240×40×H120 cm C LS 240 120 G ..</p>	<p>Library height 160 cm Closed version with flap door 240×45×H80 cm C LS 240 160 A .. Open version 240×40×H80 cm C LS 240 160 G ..</p>
--------------------	---------------------------------------------------------------------------------------------------------------------------------------------------------------------------------------------------------------------------------------------------------------------------------------	------------------------------------------------------------------------------------------------------------------------------------------------------------------------------------------------------------------------------------------------------------------------------------------	----------------------------------------------------------------------------------------------------------------------------------------------------------------------------------------------------------------------------------------------------------------------------------------

TABLES AND CABINETS FINISHES

Liquid coating



AG
Silver painting



SG
Frosted Grey painting

For other finishes,
please contact our Sales Department



ISO 9001



ISO 14001

UniFor has management system certified according to UNI EN ISO 9001 and UNI EN ISO 14001. The products are in conformance with the Italian decree law DLGS 81:2008 and with all of the principal regulations applicable to the various types of products.

The products described in this catalog are made with class E1 materials (low formaldehyde content) and are Greenguard® certified.