

TDS
Technical Data Sheet

Release Date
2023



The carefully designed colour scheme and new constructive details of LessLess Color permit the creation of workspaces where the tables, desks, and containers are combined with a high degree of compositional and chromatic freedom.

The tables and desks of this family of furnishings feature an exclusive worktop with a linoleum insert in the same colour as the aluminium frame. The tables are also available with a cable management system consisting of cable hatches, cable trays below the top, and legs that double as cable risers.

The LessLess Color series is available in a range of eight colours, complete with metal drawer pedestals and document storage cabinets with doors, in various heights.

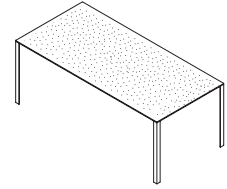
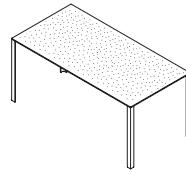
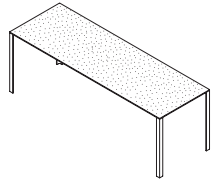

TABLES

Tables with depth 70 cm

140×70×H72 cm
C LL 140 70 F ..

Tables with depth 80 cm

160×80×H72 cm
C LL 160 80 F ..

Tables with depth 90 cm

190×90×H72 cm
C LL 190 90 F ..

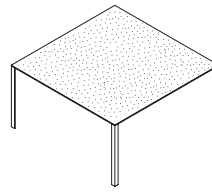
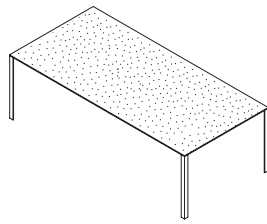

Tables with depth 110 cm

230×110×H72 cm
C LL 230 110 F ..

Square table

140×140×H72 cm
C LL 140 140 F .

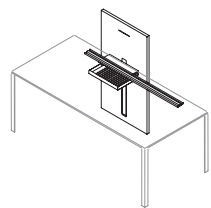

Structural panel with monitor support, cable housing and cable basket

65×2,2×H120 cm
C LL PAN RC ..

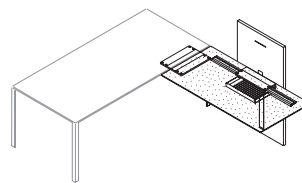

Extension and structural panel with monitor support, cable housing and cable basket

140×70×H72 cm
C LL 140 70L VF ..

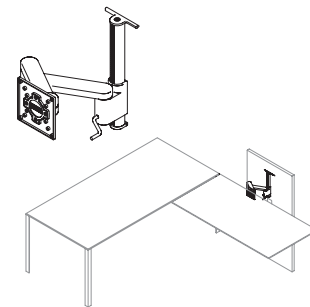
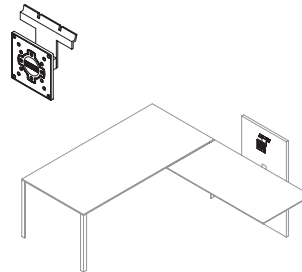
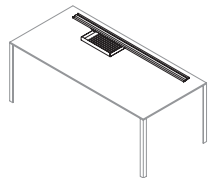

ACCESSORIES

Cable tray
Black only

41x29xH7 cm
C LL CES ..

Jointed monitor holder
Black only

15x15xH6,6 cm
C LL AGG MO ..

**Adjustable swing-arm
monitor holder**

24x19xH29 cm
I A FS R2 Z01 ..

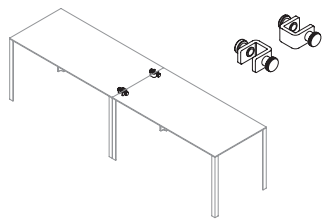

Pair of clamps for joining tables
Black only

4x3,2xH4 cm
C LL AGG TA ..

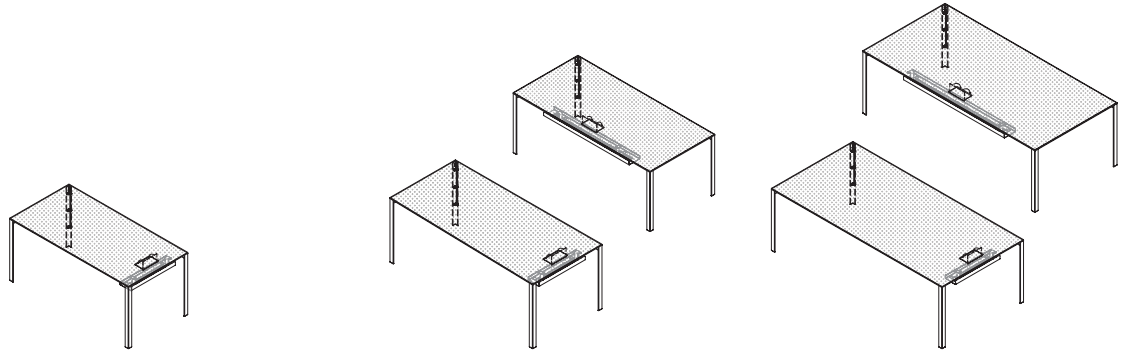

TABLE PRE-ARRANGED FOR ELECTRIFICATION

Tables with depth 80 cm, with flip access, leg suitable for cable entry and cable tray

Flip access door and cable tray (C LL CES 060 L) on the short side
160×80×H72 cm
C LM 160 80 F W L ..

Tables with depth 90 cm, with flip access, leg suitable for cable entry and cable tray

Flip access door and cable tray (C LL CES 120 C) on the long side
190×90×H72 cm
C LM 190 90 F W C ..

Tables with depth 110 cm, with flip access, leg suitable for cable entry and cable tray

Flip access door and cable tray (C LL CES 135 C) on the long side
230×110×H72 cm
C LM 230 110 F W C ..

Flip access door and cable tray (C LL CES 060 L) on the short side
190×90×H72 cm
C LM 190 90 F W L ..

Flip access door and cable tray (C LL CES 060 L) on the short side
230×110×H72 cm
C LM 230 110 F W L ..

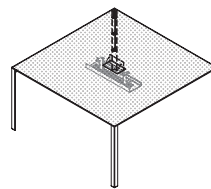
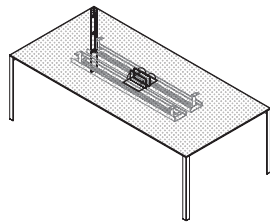

Tables with depth 110 cm, with n.2 centred flip access, leg suitable for cable entry and n.2 cable trays

Flip access door and n.2 cable tray (C LL CES 135 C) centred on the top
230×110×H72 cm
C LM 230 110 F W D ..

Tables with depth 110 cm, with n.2 centred flip access, leg suitable for cable entry and cable tray

Flip access door and cable tray (C LL CES 060 C) centred on the top
140×140×H72 cm
C LM 140 140 F W C ..

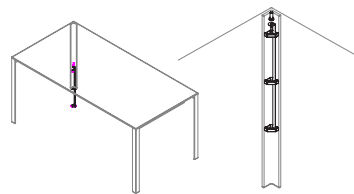
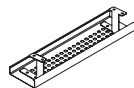

ELECTRIFICATION

Cable tray for table with flip access door

For table (C LL 160 80 F S L), (C LL 190 90 F S L), (C LL 230 110 F S L)
60×15×H4 cm
C LL CES 060 L ..

For table (C LL 140 140 F S C)
60×15×H4 cm
C LL CES 060 C ..

For table (C LL 190 90 F S C)
120×15×H4 cm
C LL CES 120 C ..

For table (C LL 230 110 F S C)
e (C LL 230 110 F S L)
135×15×H4 cm
C LL CES 135 C ..

Leg predisposition for cables
Black only

C LL A SC ..

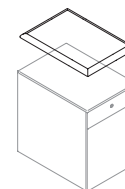
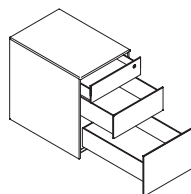
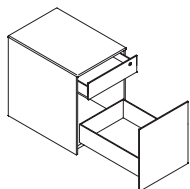

CABINETS

2 drawers pedestal
On wheels only

37x53xH53,5 cm
C LL 37 53 C2N ..

3 drawers pedestal
On wheels only

37x53xH53,5 cm
C LL 37 53 C3N ..

Cushion for pedestal

37x53xH3 cm
C LL CUS 37 ..

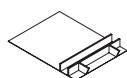

Storage tray
Trasparent only

32x42xH4,2 cm
D DS 532 ..

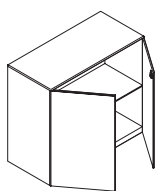

**Cabinet with doors width 80 cm,
depth 37,5 cm**
n.1 internal shelf

80x37,5xH53 cm
C LL 080 072 MA M ..

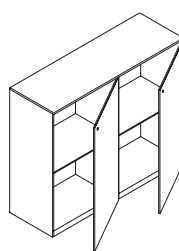

**Cabinet with doors width 110 cm,
depth 37,5 cm**
n.2 internal shelves

110x37,5xH53 cm
C LL 110 053 MA M ..

110x37,5xH91 cm
C LL 110 091 MA M ..

110x37,5xH128 cm
C LL 110 128 MA M ..

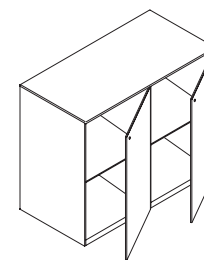

**Cabinet with doors width 110 cm,
depth 45 cm (USA)**
n.2 internal shelves

110x45xH53 cm
C LL 110 053 MA 4M ..

110x45xH91 cm
C LL 110 091 MA 4M ..

110x45xH128 cm
C LL 110 128 MA 4M ..

TABLES FINISHES

Table top: Linoleum
Structure: Epoxy powder coating



U0/D4
Salsa linoleum (U0)
Salsa painting (D4)



U3/D7
Charcoal linoleum (U3)
Charcoal painting (D7)



U4/FU
Mushroom linoleum (U4)
Mushroom painting (FU)

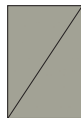

U8/3T
Pebble linoleum (U8)
Pebble painting (3T)



U9/T0
Ash linoleum (U9)
Ash painting (T0)



UD/FW
Mauve linoleum (UD)
Mauve painting (FW)



UE/FX
Conifer linoleum (UE)
Conifer painting (FX)



UF/T2
Black linoleum (UF)
Nero painting (T2)

CABINETS FINISHES

Epoxy powder coating



D4
Salsa painting



D7
Charcoal painting



FU
Mushroom painting



3T
Pebble painting



T0
Ash painting



FW
Mushroom painting



FX
Conifer painting



T2
Black painting

CUSHION FINISHES

Fabric



TE
Black Scuba fabric

ACCESSORIES AND MONITOR ARMS FINISHES

Epoxy powder coating



KS
Soft Black painting

For other finishes,
please contact our Sales Department



ISO 9001



ISO 14001

UniFor has management system certified according to UNI EN ISO 9001 and UNI EN ISO 14001. The products are in conformance with the Italian decree law DLGS 81:2008 and with all of the principal regulations applicable to the various types of products.

The products described in this catalog are made with class E1 materials (low formaldehyde content) and are Greenguard® certified.