

UniFor

MDL System

Sistema di scrivanie singole, postazioni professionali aggregate in linea o fronteggianti, tavoli per riunioni di varie forme e dimensioni complete di attrezzatura per il cablaggio, mensole e pannelli divisorii. Pochi componenti di un unico sistema costruttivo si combinano con semplicità per risolvere ogni aspetto progettuale.

La struttura metallica costituita da binari sotto piano e gambe sagomate in estruso di alluminio anodizzato lucido, naturale o verniciato, è dotata di un particolare sistema di fissaggio che consente di posizionare i vari elementi secondo necessità.

Piano di lavoro in laminato ad alte prestazioni, colorato nella massa con finitura superficiale opaca e bordo smussato.



MDL System

MDL Full

Caratterizzato dal particolare profilo a C disegnato dal piano di lavoro che realizza un'originale mensola di servizio fornita di pratici cassette portaoggetti e predisposta per la connessione alla rete. La dotazione funzionale è completata da vassoio porta cavi, piano ausiliario e cassettera metallica su ruote.

MDL Basic Plus

Tavolo operativo attrezzato con mensola di servizio a L. Pannello di schermatura posizionabile secondo necessità e canalizzazione sotto piano.

MDL System Meeting

Tavolo costituito da una robusta struttura metallica e un elegante piano con bordo smussato. Può essere attrezzato con vano tecnico sotto piano predisposto per l'allacciamento alla rete e accessibile mediante uno sportello a filo piano.

Piani

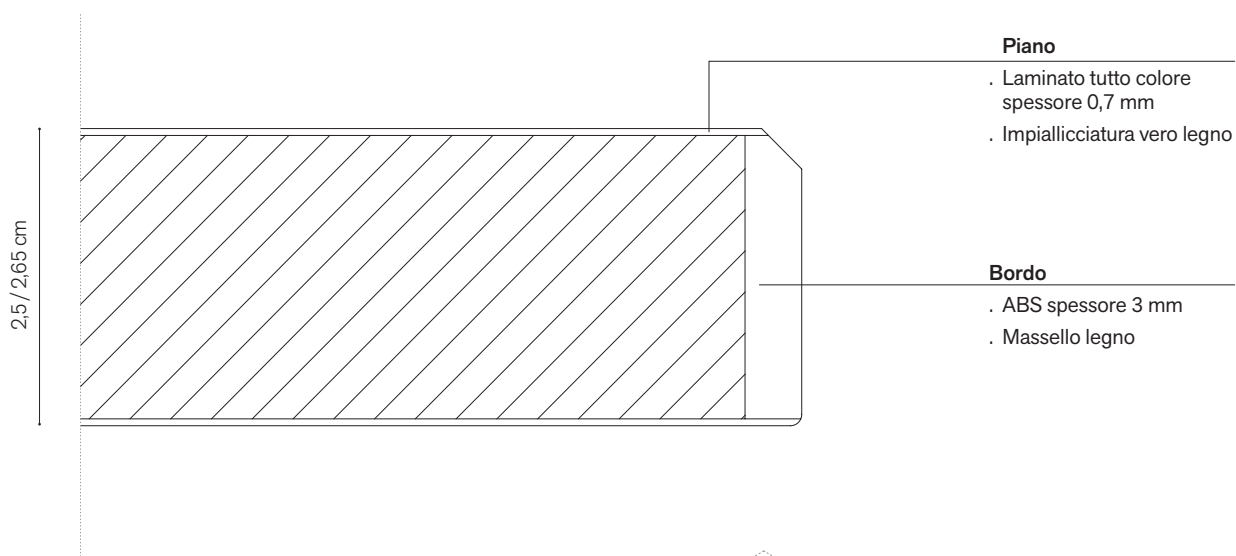

Piani Full

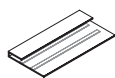

Piano singolo Full

180x90xH12 cm
G DL PI 180 90A ..

210x90xH12 cm
G DL PI 210 90A ..

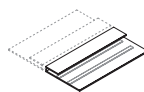

Piano doppio Full

180x90xH12 cm
G DL PI 180 90AD ..

210x90xH12 cm
G DL PI 210 90AD ..

Piani Basic 80

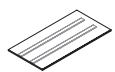

Piano per postazione singola profondità cm. 80

160x80xSp2,6 cm
G DL PI 160 80 ..

180x80xSp2,6 cm
G DL PI 180 80 ..

210x80xSp2,6 cm
G DL PI 210 80 ..

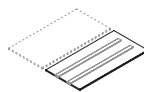

Piano per postazione doppia profondità cm. 80

160x80xSp2,6 cm
G DL PI 160 80 D ..

180x80xSp2,6 cm
G DL PI 180 80 D ..

210x80xSp2,6 cm
G DL PI 210 80 D ..

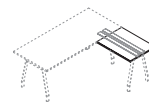

Allunghi per piani rettangolari

80x60xSp2,6 cm
G DL PI 080 60 L ..

100x60xSp2,6 cm
G DL PI 100 60 L ..

Gambe



Gamba per postazione singola

64x5 cm
 G DL GA 64 ..



Gamba per postazione doppia

136x5 cm
 G DL GA 136 D ..

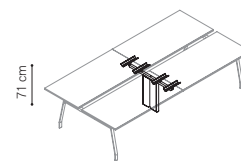

Gamba centrale/ salita cavi fissa per postazioni doppie

48,7x50 cm
 G DL GD F ..



Gamba centrale/ salita cavi fissa per postazioni in linea

48,7x50 cm
 G DL GS F ..



Gamba per allungo

48x5 cm
 G DL GA 48 L ..

Accessori



Mensola soprapiano a L

160x26xH16 cm
 G DL ME 160 ..

180x26xH16 cm
 G DL ME 180 ..

210x26xH16 cm
 G DL ME 210 ..



Schermo divisorio

160x2,4 cm
 G DL SC 160 36 ..

180x2,4 cm
 G DL SC 180 36 ..

210x2,4 cm
 G DL SC 210 36 ..



Cestello per raccolta abbondanza cavi

100x20xH3 cm
 G DL WB 100 ..

125x20xH3 cm
 G DL WB 125 ..

150x20xH3 cm
 G DL WB 150 ..

200x20xH3 cm
 G DL WB 200 ..

Accessori



Vassoio in policarbonato per piani Full

24,5x30,5xH6,9 cm
G DL CS 25 ..
Solo per piani Full.
Solo trasparenti



Kit per l'unione di piani ortogonali

12x8,6xH4 cm
G DL DG ..
Solo Grigio Platino



Porta unità centrale

30x14/17 cm
G DL A UNI ..
Solo Grigio Ombra

Tavoli Meeting Q

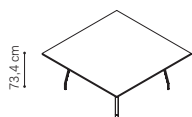

Tavoli quadrati

100x100 cm
G DL 100 Q ..
120x120 cm
G DL 120 Q ..
140x140 cm
G DL 140 Q ..
160x160 cm
G DL 160 Q ..
180x180 cm
G DL 180 Q ..

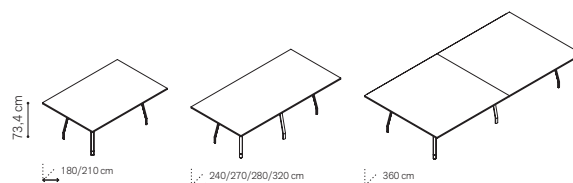

Tavoli rettangolari

180x120 cm
G DL 180 120 Q ..
210x140 cm
G DL 210 140 Q ..
240x120 cm
G DL 240 120 Q ..
240x160 cm
G DL 240 160 Q ..
270x180 cm
G DL 270 180 Q ..
280x140 cm
G DL 280 140 Q ..
320x160 cm
G DL 320 160 Q ..
360x180 cm
G DL 360 180 Q ..

Tavoli Meeting R-S



Tavoli tondi

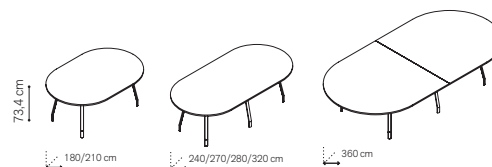

- 80x80 cm**
G DL 080 R ..
- 90x90 cm**
G DL 090 R ..
- 100x100 cm**
G DL 100 R ..
- 120x120 cm**
G DL 120 R ..
- 140x140 cm**
G DL 140 R ..
- 160x160 cm**
G DL 160 R ..
- 180x180 cm**
G DL 180 R ..



Tavoli ovali





- 180x120 cm**
G DL 180 120 S ..
- 210x140 cm**
G DL 210 140 S ..
- 240x120 cm**
G DL 240 120 S ..
- 240x160 cm**
G DL 240 160 S ..
- 270x180 cm**
G DL 270 180 S ..
- 280x140 cm**
G DL 280 140 S ..
- 320x160 cm**
G DL 320 160 S ..
- 360x180 cm**
G DL 360 180 S ..

Finiture piani / combinazioni tavoli - piani/strutture

	S4 Laminato bianco		RY Laminato Rovere 6L6		NK Noce canaletto rigato
	GP Laminato grigio platino		AS Acero Sicomoro		5R Rovere termotrattato
	LS Laminato Sicomoro		RV Rovere		

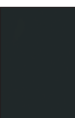
Finiture gambe-strutture / Elettificazione - Accessori

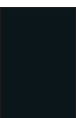
Verniciatura con polvere epossidica

	D7 Grigio scuro Charcoal		VP Grigio platino		KS Nero Soft
	T0 Grigio medio Ash		C7 Bianco Calce		













Finiture gambe-strutture

Trattamento galvanico

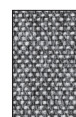
	BA Alluminio Brillantato		NA Alluminio Naturale
---	------------------------------------	---	---------------------------------

Finiture schermi pensili

Schermi pensili rivestiti in tessuto o laminato con profili D7 - TO - VP - C7 - KS
Schermi pensili in vetro con profili in policarbonato

	S4 Laminato bianco		LS Laminato Sicomoro		
	GP Laminato grigio platino		RY Laminato Rovere 6L6		
	J2 Tessuto Cliente		Q1 Tessuto Chip		K3 Tessuto Remix 2
	J3 Tessuto Mirage		Q2 Tessuto File		K4 Tessuto Sole
	Q0 Tessuto Revive 1		Q3 Tessuto Note		CS Cristallo Satinato



ISO 9001



ISO 14001

UniFor ha ottenuto le certificazioni dei sistemi di gestione UNI EN ISO 9001 e UNI EN ISO 14001. I prodotti sono conformi all'allegato DLGS 81:2008 e rispondenti alle principali norme applicabili ai diversi tipi di prodotti.

I prodotti descritti nel catalogo sono composti da materiali in classe E1 (a basso contenuto di formaldeide), e hanno ottenuto la certificazione Greenguard®.