

UniFor

Move 010

Multipurpose trolley for multimedia equipment.

The structure consists of a base, two sides, and back in painted steel. The base has 4 wheels in black nylon, of which two swivel castors with brakes and two fixed directional wheels. There is a space for the passage of cables and the insertion of a flexible cable gland of the type A/SCF. Within the sides, the extruded aluminum profile provides for the insertion and height adjustment of shelves, as well as acting as a cable riser for any equipment placed on or in the trolley.

The painted steel shelves can be adjusted to any position, even when fully loaded. The structure of the trolley is in steel with epoxy powder coating. A monitor can be attached by means of a height-adjustable support.



Move composition components
scheme with two shelves
and small monitor support

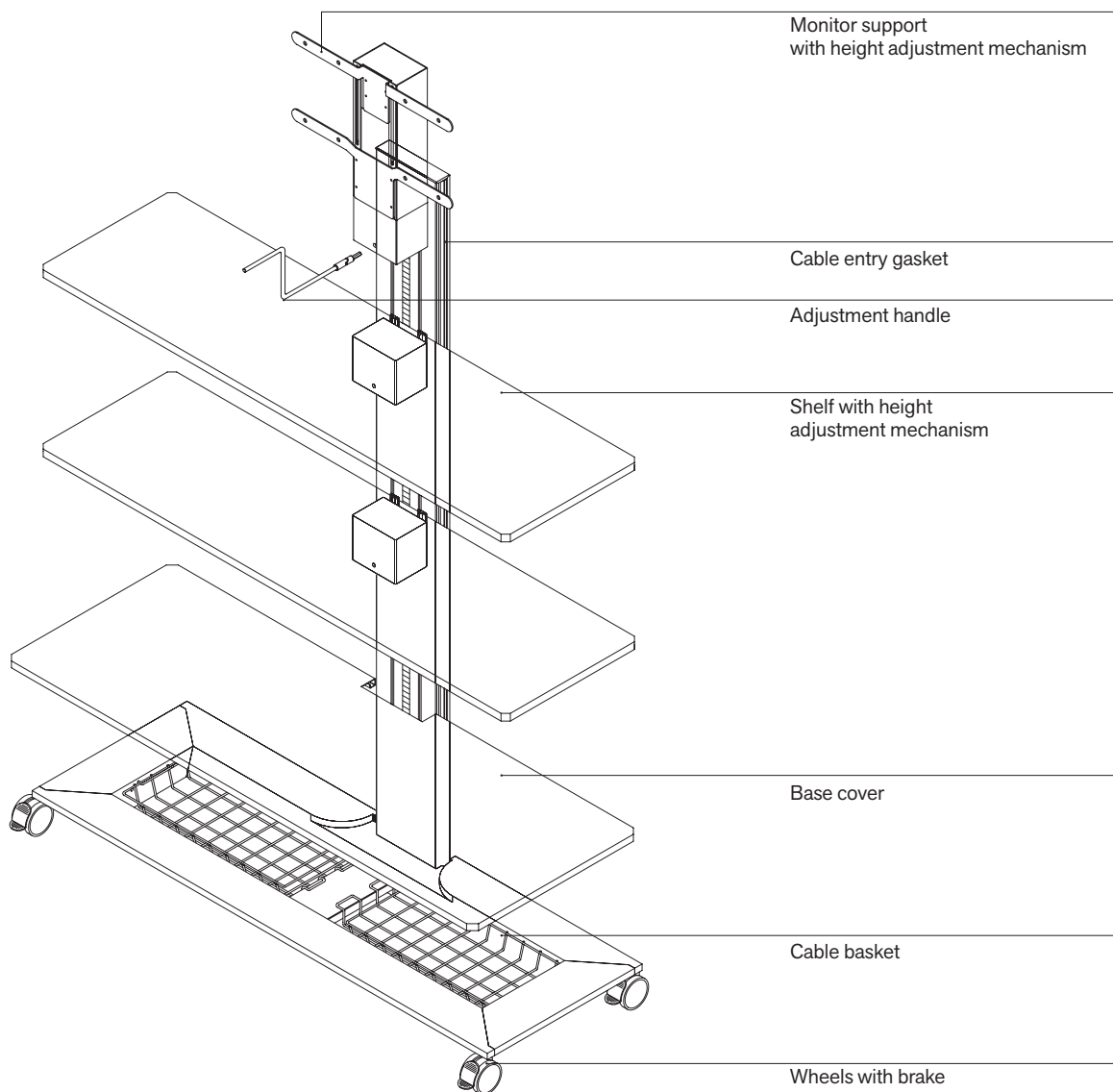

Complete trolley

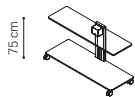

Complete Move with 1 shelf

140x50 cm
B MO 140 075 ..

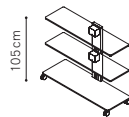

Complete Move with 2 shelves

140x50 cm
B MO 140 105 ..

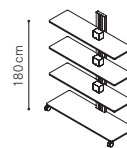

Complete Move with 3 shelves

140x50 cm
B MO 140 180 ..

Separate components

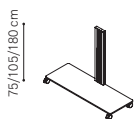

Supporting structure

140x50xH75 cm
B MO 140 075 S ..
140x50xH105 cm
B MO 140 105 S ..
140x50xH180 cm
B MO 140 180 S ..



Shelf

140x40xH2 cm
B MO R 140 ..
complete
of gearbox

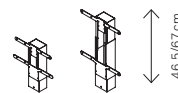

Height adjustable holder for small monitor

43x9,3 cm
B MO S MO P ..
Suggested monitor:
50/55 inches.
VESA mounts cm. 20x20,
40x20, 40x30, 40x40

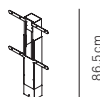

Height adjustable holder for big monitor

48x9,3 cm
B MO S MO G ..
Suggested monitor:
60/65/70 inches.
VESA mounts cm. 40x40

Structures finishes

Epoxy powder coating



PX
Frosted silver



UniFor has management system certified according to UNI EN ISO 9001 and UNI EN ISO 14001.

The products are in conformance with the Italian decree law DLGS 81:2008 and with all of the principal regulations applicable to the various types of products.

The products described in this catalog are made with class E1 materials (low formaldehyde content) and are Greenguard® certified.