

# UniFor

## MDL Light

MDL Light is a system of task workstation tables with straight edges. The table top of the desk-table can be equipped with cable passages and baskets below the surface for cable management, with easy access through special hatches. The contoured legs are in extruded aluminum with a polished or natural finish or epoxy powder coating. Raceways within the legs permit the passage of cables from floor level to the cable management baskets below the table top.

The workstations can be separated by a divider panel. The aluminum strip along the top of the panel is designed for mounting shelves, containers for small items (folders, trays), and a hinged monitor support arm.



**Table tops**

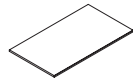
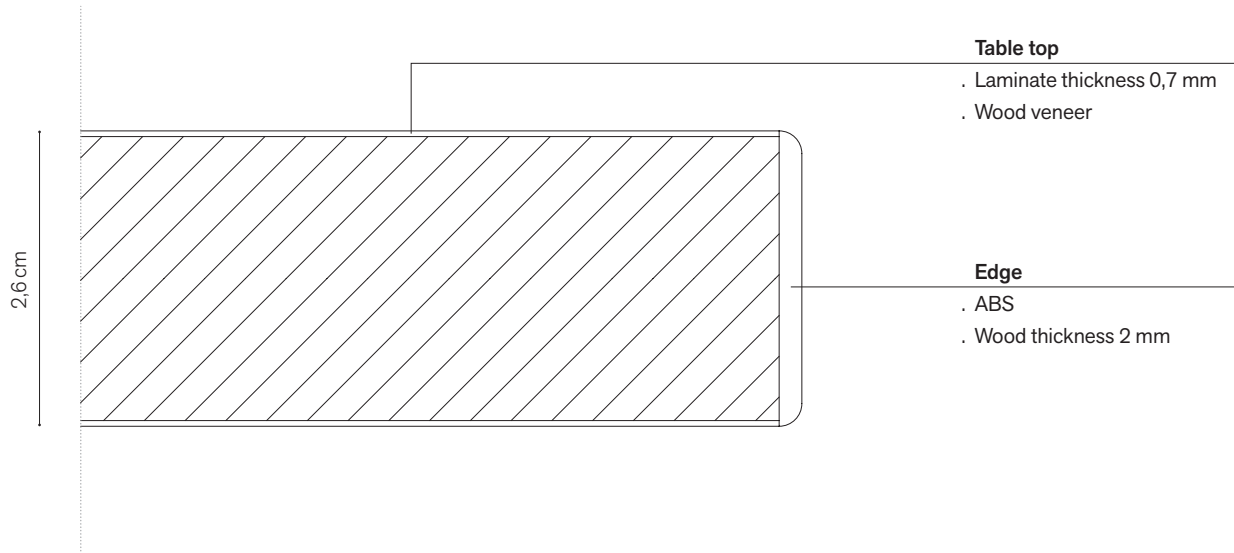

**Table tops**

**140x80xTh2,6 cm**  
G DB PI 140 80 ..

**160x80xTh2,6 cm**  
G DB PI 160 80 ..

**180x80xTh2,6 cm**  
G DB PI 180 80 ..

**Legs**



**Height-fixed leg**

**5x36 cm**  
G DB GA S F ..

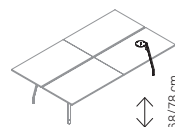

**Height-adjustable leg**

**5x36 cm**  
G DB GA S R ..

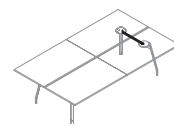

**Support crossbar for double tops**

**50x2xH2 cm**  
G DL PR 50 ..  
Only Platinum Grey

### Legs



**Height-fixed center leg/cable riser for double workstations**

110x74 cm  
G DB GD F..

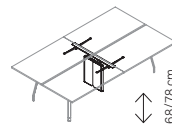

**Height-adjustable center leg/cable riser for double workstations**

110x74 cm  
G DB GD R..

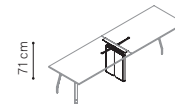

**Height-fixed center leg/cable riser for aligned workstations**

60x74 cm  
G DB GS F..

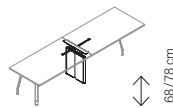

**Height-adjustable center leg/cable riser for aligned workstations**

60x74 cm  
G DB GS R..

### Accessories

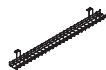

**Cable tray**

100x10xH3,8 cm  
G DB WB 100 ..

125x10xH3,8 cm  
G DB WB 125 ..

150x10xH3,8 cm  
G DB WB 150 ..

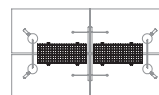

**Double cable tray for double workstation**

75x40xH10,2 cm  
G DB WB 75 D ..  
only for table tops with flip access door  
I SP 030 10 Z02,  
I SP 030 10 Z08  
or without flip access door

100x40xH10,2 cm  
G DB WB 100 D ..  
only for table tops with flip access door  
I SP 030 10 Z02,  
I SP 030 10 Z08  
or without flip access door

125x40xH10,2 cm  
G DB WB 125 D ..  
only for table tops with flip access door  
I SP 030 10 Z02,  
I SP 030 10 Z08  
or without flip access door



**CPU holder**

30x14/17 cm  
I A UNI Z23 ..  
only Shadow Grey

### Accessories

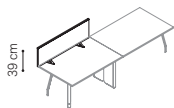

#### Hanging screens for single table tops

**120x2,4 cm**  
G DB SC 120 S ..

**140x2,4 cm**  
G DB SC 140 S ..

**160x2,4 cm**  
G DB SC 160 S ..

**180x2,4 cm**  
G DB SC 180 S ..



#### Hanging screens for double table tops









**120x2,4 cm**  
G DB SC 120 D ..

**140x2,4 cm**  
G DB SC 140 D ..

**160x2,4 cm**  
G DB SC 160 D ..

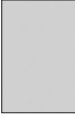

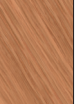

**180x2,4 cm**  
G DB SC 180 D ..

### Table tops finishes

	<b>4S</b> White melamine		<b>S4</b> White Laminate		<b>RY</b> Oak 6L6 Laminate
	<b>PN</b> Platinum grey melamine		<b>GP</b> Platinum grey Laminate		<b>AS</b> Sycamore
	<b>NY</b> Oak melamine		<b>LS</b> Sycamore Laminate		<b>RV</b> Oak

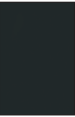
### Legs - Structures / Electrification - Accessories finishes

Epoxy powder coating

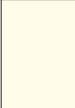
	<b>D7</b> Charcoal dark grey		<b>VP</b> Platinum grey		<b>KS</b> Soft Black
	<b>T0</b> Ash medium grey		<b>C7</b> Calce white		









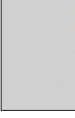
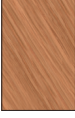

### Legs - Structures finishes

Galvanic treatment

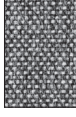
	<b>BA</b> Polished aluminum		<b>NA</b> Natural aluminum		
---	--------------------------------	---	-------------------------------	--	--

### Hanging screens finishes

Hanging screens in fabric or laminate with profiles D7 - T0 - VP - C7 - KS  
Hanging screens in glass with polycarbonate profiles

	<b>S4</b> White Laminate		<b>LS</b> Sycamore Laminate		
	<b>GP</b> Platinum grey Laminate		<b>RY</b> Oak 6L6 Laminate		
	<b>J2</b> COM fabric		<b>Q1</b> Chip fabric		<b>K3</b> Remix 2 fabric
	<b>J3</b> Mirage fabric		<b>Q2</b> File fabric		<b>K4</b> Sole fabric
	<b>Q0</b> Revive 1 fabric		<b>Q3</b> Note fabric		<b>CS</b> Frosted glass



UniFor has management system certified according to UNI EN ISO 9001 and UNI EN ISO 14001.

The products are in conformance with the Italian decree law DLGS 81:2008 and with all of the principal regulations applicable to the various types of products.

The products described in this catalog are made with class E1 materials (low formaldehyde content) and are Greenguard® certified.